

3/8 INCH HEIGHT
SQUARE EDGE, 90° ANGLE

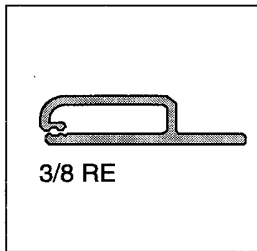

3/8 INCH HEIGHT
RADIUS (ROUND) EDGE

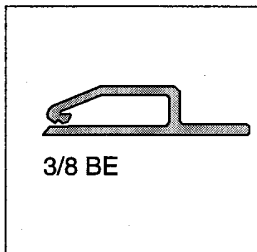

3/8 INCH HEIGHT
BEVELED EDGE, 30° ANGLE

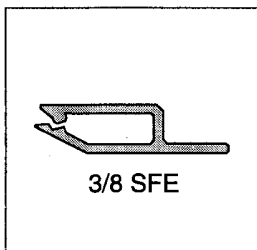

3/8 INCH HEIGHT
SQUARE FLAT EDGE

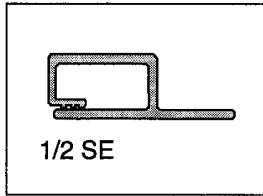

1/2 INCH HEIGHT
SQUARE EDGE, 90° ANGLE

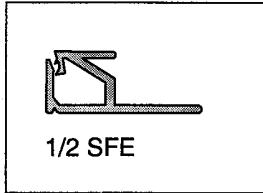

1/2 INCH HEIGHT
SQUARE FLAT EDGE

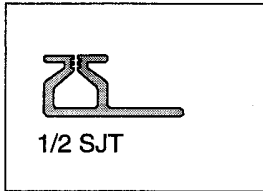

1/2 INCH HEIGHT
SQUARE JOINT

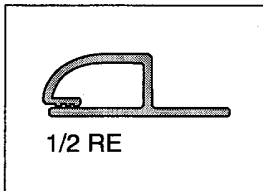

1/2 INCH HEIGHT
RADIUS (ROUND) EDGE

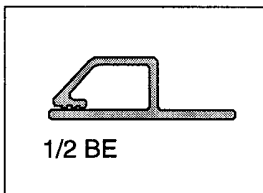

1/2 INCH HEIGHT
BEVELED EDGE, 45° ANGLE

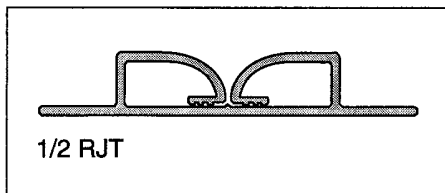

1/2 INCH HEIGHT
RADIUS (ROUND) JOINT

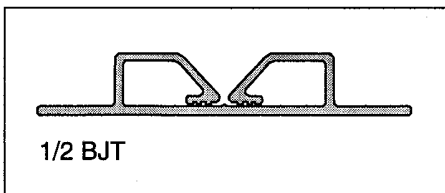

1/2 INCH HEIGHT
BEVELED JOINT, 45° ANGLE

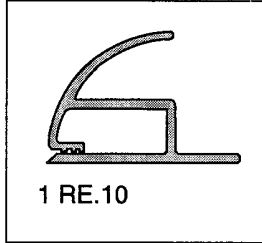

1 INCH HEIGHT
 RADIUS (ROUND) EDGE

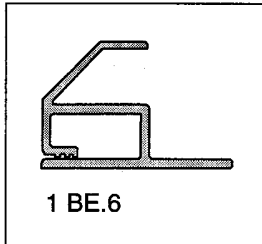

1 INCH HEIGHT
 BEVELED EDGE, 45° ANGLE
 0.6 (5/8) INCH BEVEL ANGLE RISE OVER 3/8 INCH VERTICAL

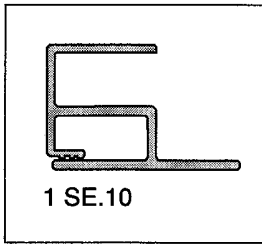

1 INCH HEIGHT
 SQUARE EDGE, 90°

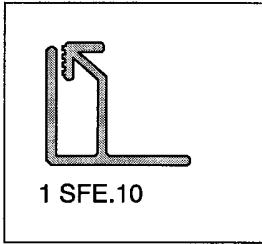

1 INCH HEIGHT
 SQUARE FLAT EDGE
 1.0 INCH BACK (ABUTTING) EDGE

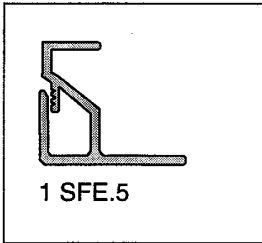

1 INCH HEIGHT
 SQUARE FLAT EDGE
 0.5 INCH BACK (ABUTTING) EDGE

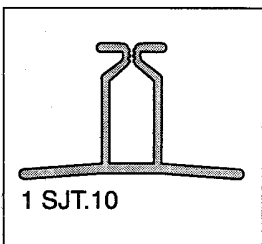

1 INCH HEIGHT
 SQUARE JOINT
 1.0 INCH (ABUTTING) EDGES

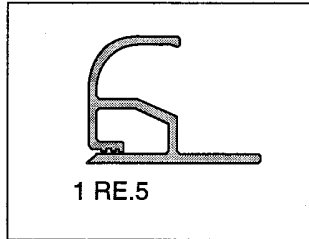

1 INCH HEIGHT
RADIUS (ROUND) EDGE
0.5 INCH RADIUS OVER 0.5 INCH VERTICAL

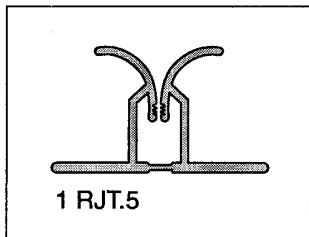

1 INCH HEIGHT
RADIUS (ROUND) JOINT
0.5 INCH RADIUS OVER 0.5 INCH VERTICAL

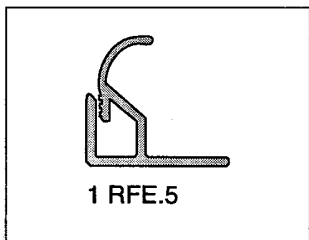

1 INCH HEIGHT
RADIUS (ROUND) FLAT EDGE
0.5 INCH RADIUS OVER 0.5 INCH VERTICAL

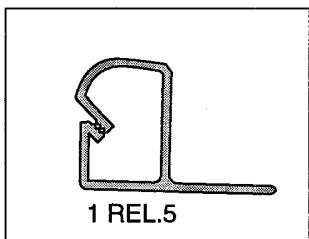

1 INCH HEIGHT
RADIUS (ROUND) EDGE LOAD
0.5 INCH RADIUS OVER 0.5 INCH VERTICAL

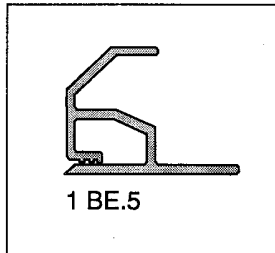

1 INCH HEIGHT
BEVELED EDGE, 45° ANGLE
0.5 INCH BEVEL ANGLE RISE OVER 0.5 INCH VERTICAL

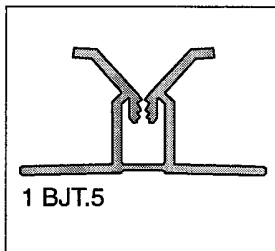

1 INCH HEIGHT
BEVELED JOINT, 45° ANGLE
0.5 INCH BEVEL ANGLE RISE OVER 0.5 INCH VERTICAL

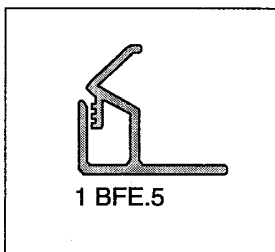

1 INCH HEIGHT
BEVELED FLAT EDGE, 45° ANGLE
0.5 INCH BEVEL ANGLE RISE OVER 0.5 INCH VERTICAL

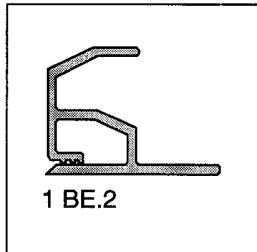

1 INCH HEIGHT
BEVELED EDGE, 60° ANGLE
0.2 (1/4) INCH BEVEL ANGLE RISE OVER
0.8 (3/4) INCH VERTICAL

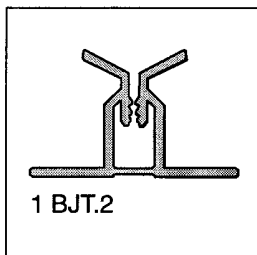

1 INCH HEIGHT
BEVELED JOINT, 60° ANGLE
0.2 (1/4) INCH BEVEL ANGLE RISE OVER
0.8 (3/4) INCH VERTICAL

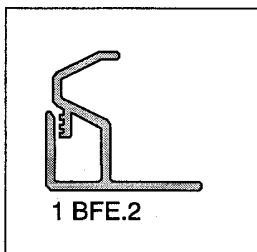

1 INCH HEIGHT
BEVELED FLAT EDGE
0.2 (1/4) INCH BEVEL ANGLE RISE OVER
0.8 (3/4) INCH VERTICAL

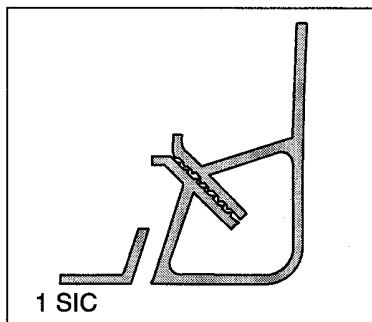

1 INCH HEIGHT
SQUARE INSIDE CORNER

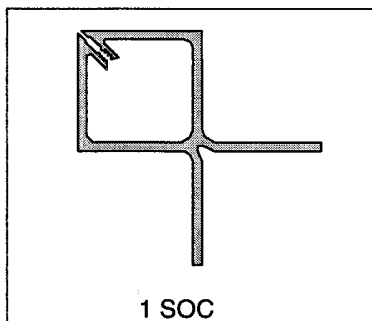

1 INCH HEIGHT
SQUARE OUTSIDE CORNER

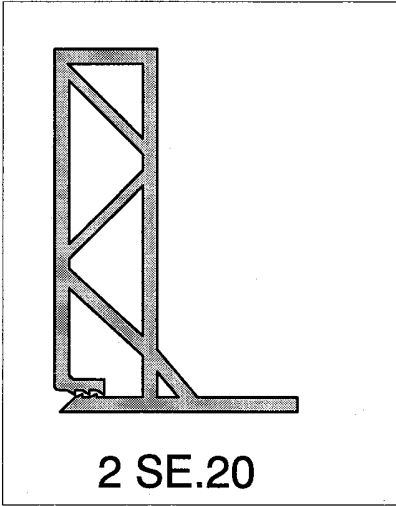

2 INCH HEIGHT
SQUARE EDGE

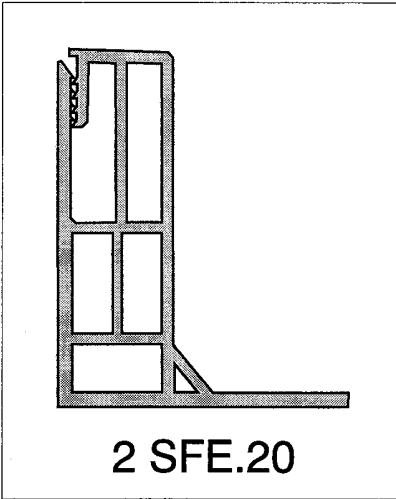

2 INCH HEIGHT
SQUARE FLAT EDGE

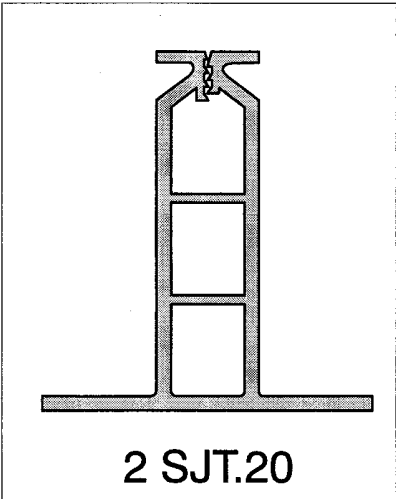

2 INCH HEIGHT
SQUARE JOINT
2 INCH (ABUTTING) EDGES